

**1 WINDOW HEAD SECTION**  
 SCALE: 8"=1'-0"  
 REF: NONE

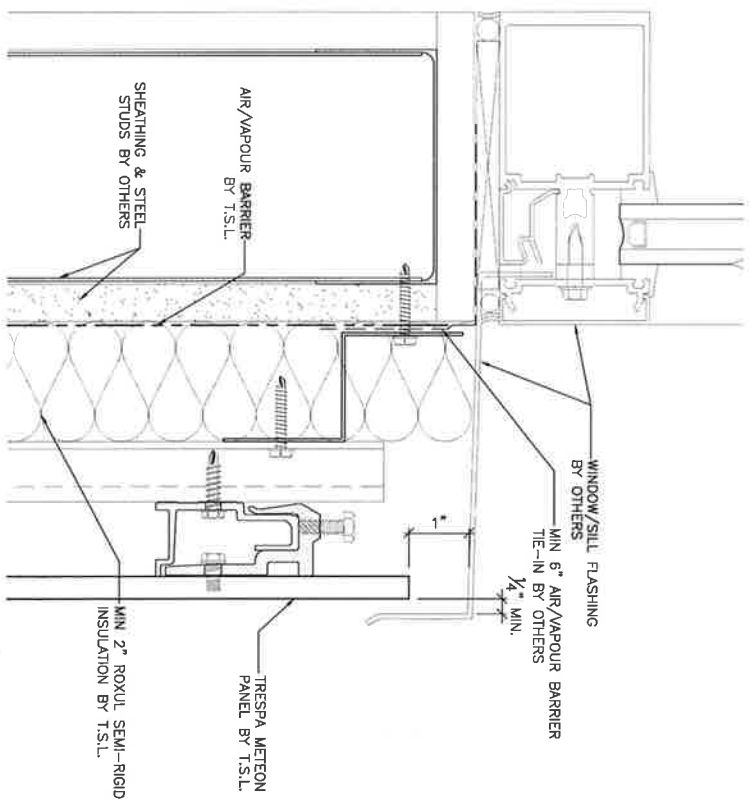

**2 WINDOW SILL SECTION**  
 SCALE: 8"=1'-0"  
 REF: NONE

"BUILDING INSPIRED VISIONS"

**Copyright Notice**  
 THIS DRAWING AND ITS CONTENTS ARE PROTECTED BY COPYRIGHT AND SHALL NOT BE REPRODUCED IN ANY MANNER WITHOUT THE WRITTEN PERMISSION OF THERMAL SYSTEMS INC. TD. THESE DRAWINGS ARE NOT TO BE SCALED.

REV. NO.	REVISIONS	DATE	BY



**THERMAL SYSTEMS**

SECTION DETAILS	
PROJECT	TRESPA DETAILS
LOCATION	XXXXXXXX
DATE	XXXXXXXX

SCALE	AS SHOWN	DATE	BY
NAME	ASS	DATE	
DATE	03		
PROJ. No.	90070912	REV.	0

**C-5.01**

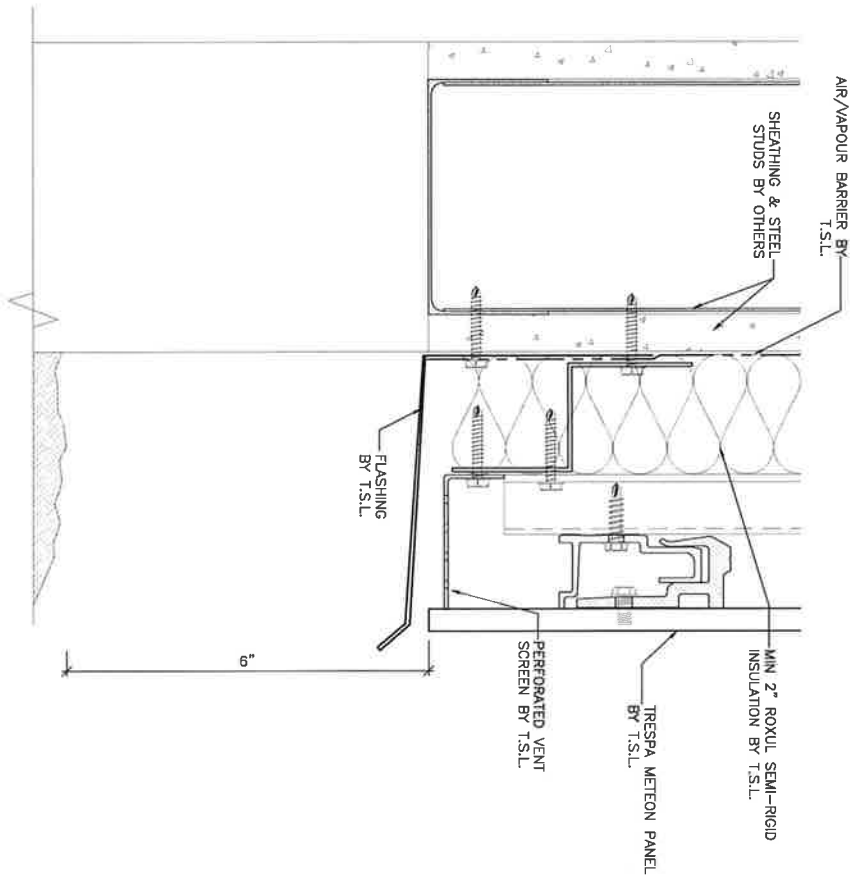

**1 BASE SECTION**  
 SCALE: 6"=1'-0"  
 REF: NONE

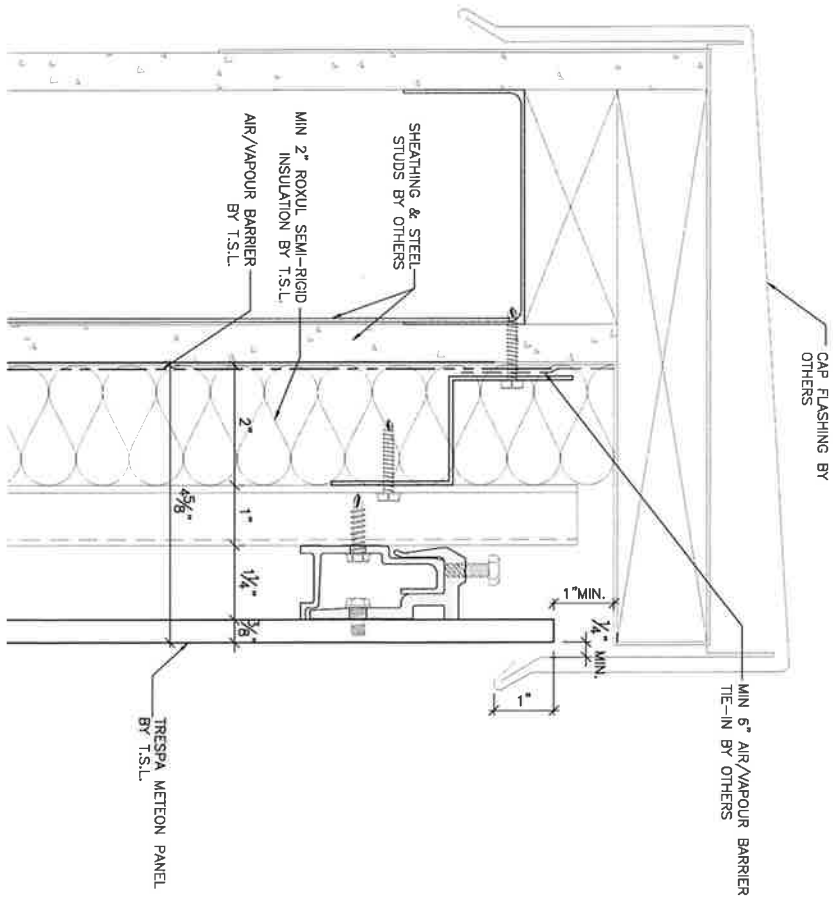

**2 PARAPET SECTION**  
 SCALE: 6"=1'-0"  
 REF: NONE

"BUILDING INSPIRED VISIONS"

**Disclaimer Notice**  
 THIS DRAWING AND ITS CONTENTS ARE PROTECTED BY COPYRIGHT AND SHALL NOT BE REPRODUCED IN WHOLE OR IN PART WITHOUT THE EXPRESS WRITTEN PERMISSION OF THERMAL SYSTEMS. THESE DRAWINGS ARE NOT TO BE SCALED.

REV. NO.	DESCRIPTION	DATE	BY



SECTION TITLE
SECTION DETAILS
PROJECT: TRESPA DETAILS
CLIENT: XXXXXXX
DATE: XXXXXXX

STATUS	DATE	BY
AS SHOWN	XX-XX-XX	
ISS		
CO		

NO. 0



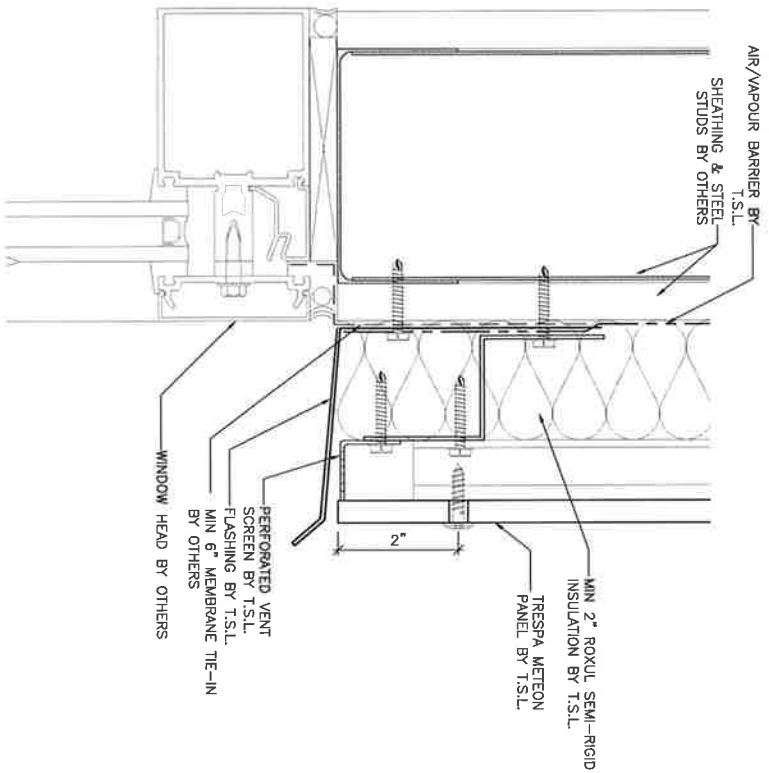

**1 WINDOW HEAD SECTION**  
SCALE: 6"=1'-0"  
REF: NONE

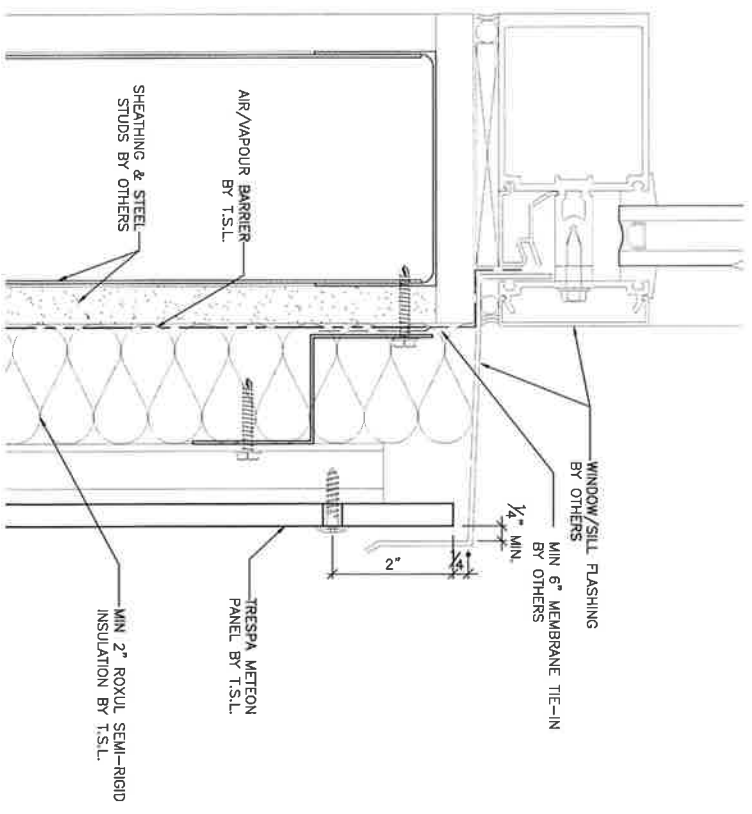

**2 WINDOW SILL SECTION**  
SCALE: 6"=1'-0"  
REF: NONE

"BUILDING INSPIRED VISIONS"

**General Notes**  
THIS DRAWING AND ITS CONTENTS ARE PROTECTED BY COPYRIGHT AND SHALL NOT BE REPRODUCED IN WHOLE OR IN PART WITHOUT THE WRITTEN PERMISSION OF THERMAL SYSTEMS, INC. THESE DRAWINGS ARE NOT TO BE SCALED.

REV.	NO.	DESCRIPTION	DATE	BY	CHK.

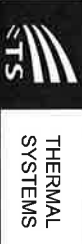

SECTION DETAILS	
PROJECT	TRESPA DETAILS
LOCATION	XXXXXXXX
DATE	XXXXXXXX

SCALE	AS SHOWN	DATE
SCALE	AS SHOWN	30-00-00
DATE	30-00-00	30-00-00
REV.	0	E-5.01

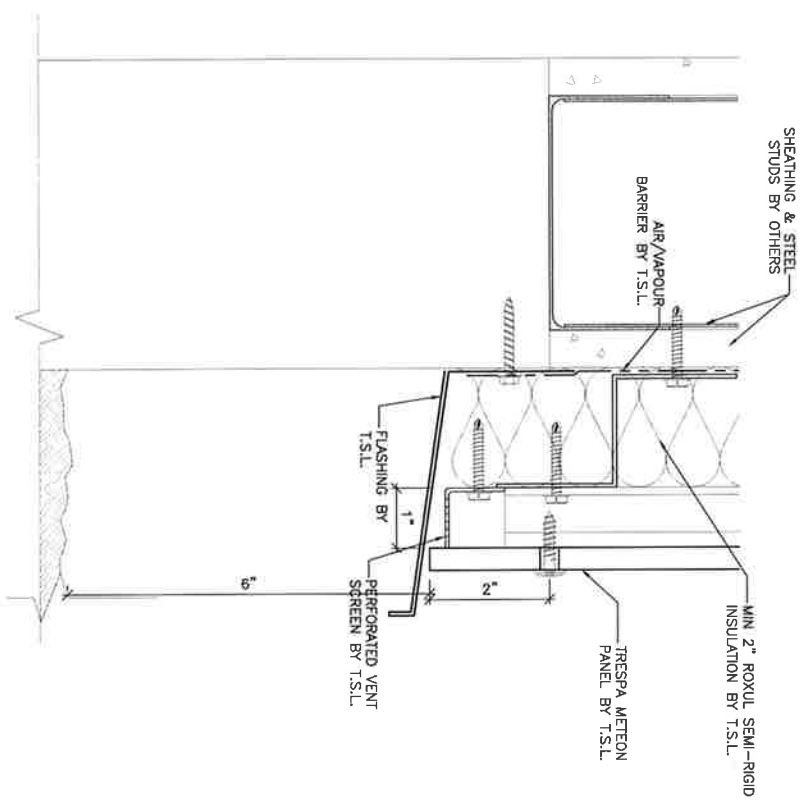

**1 BASE SECTION**  
 SCALE: 8"=1'-0"  
 REF: NONE

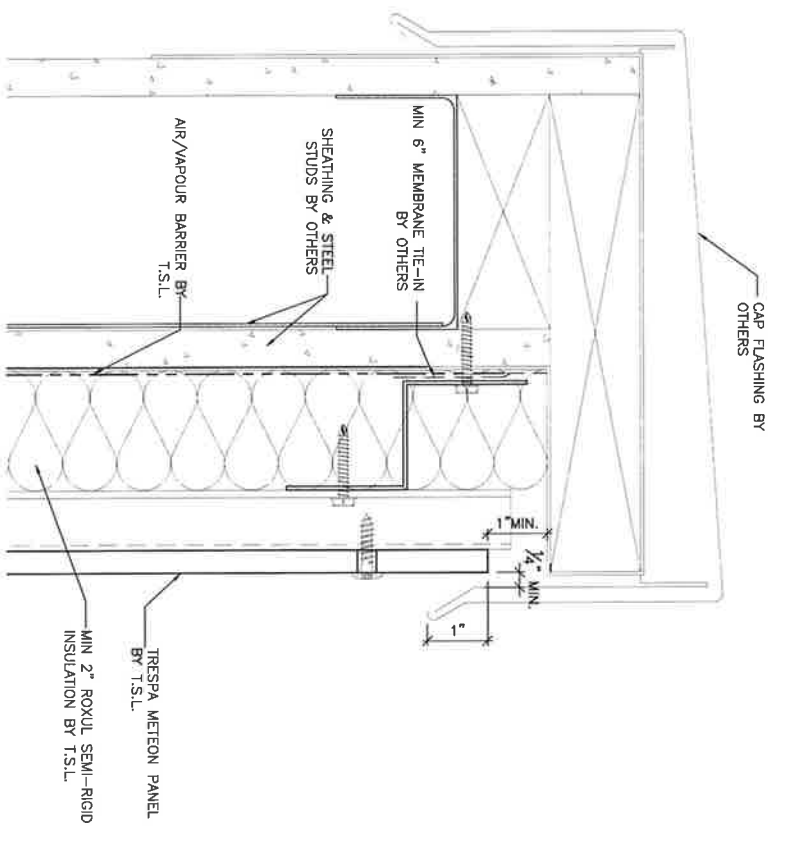

**2 PARAPET SECTION**  
 SCALE: 8"=1'-0"  
 REF: NONE

"BUILDING INSPIRED VISIONS"

**General Notes**  
 THIS DRAWING AND ITS CONTENTS ARE PROTECTED BY COPYRIGHT AND SHALL NOT BE REPRODUCED IN WHOLE OR IN PART WITHOUT THE EXPRESS WRITTEN PERMISSION OF THERMAL SYSTEMS. DRAWINGS ARE NOT TO BE SCALED.

REV.	DESCRIPTION	DATE	BY



**THERMAL SYSTEMS**

PROJECT TITLE	SECTION DETAILS
PROJECT: TRESPA METEON	SECTION DETAILS
LOCATION: XXXXXX	
CONTINENT: XXXXXX	

SCALE	AS SHOWN	DATE	BY
SCALE: MSS	AS SHOWN	DATE: XXX-XX-XX	BY: MSS
DATE: 08		PROJECT: E-5.02	REV: 0
FILE NO.: B0070112			



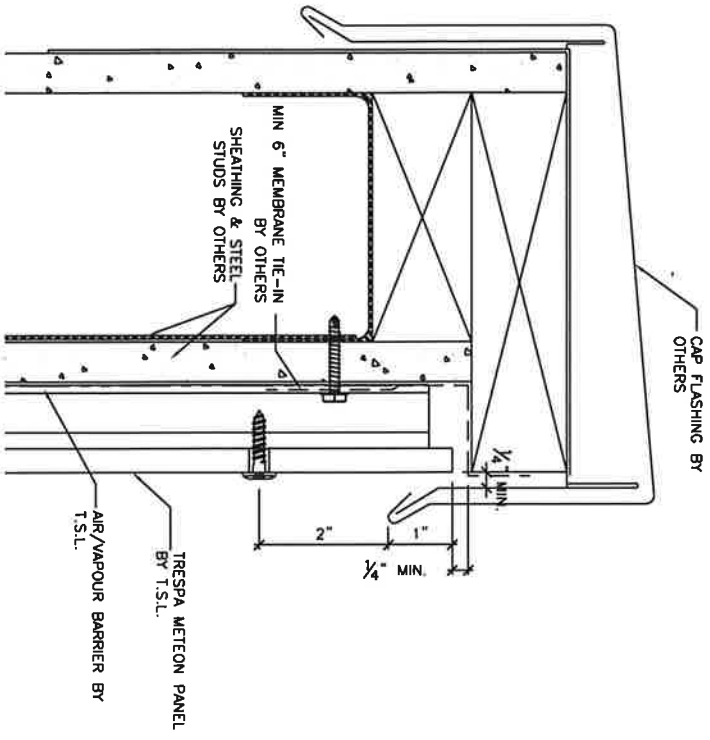

1 PARAPET SECTION  
 SCALE: 6"=1'-0"  
 REF: NONE

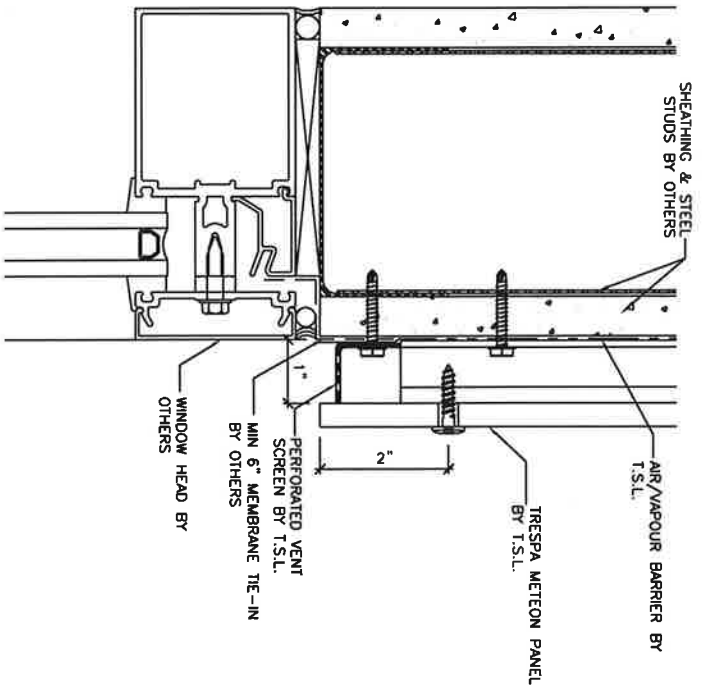

2 WINDOW HEAD SECTION  
 SCALE: 6"=1'-0"  
 REF: NONE

"BUILDING INSPIRED VISIONS"

**Considered Under**  
 THIS DRAWING AND ITS CONTENTS ARE PROTECTED BY COPYRIGHT AND SHALL NOT BE REPRODUCED IN WHOLE OR IN PART WITHOUT THE EXPRESS WRITTEN PERMISSION OF THE DESIGNER. DIMENSIONS ARE NOT TO BE SCALED.

REV. NO.	DESCRIPTION	DATE	BY

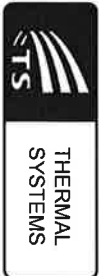

**SECTION DETAILS**  
 PROJECT: TRESPA DETAILS  
 LOCATION: XXXXXX  
 DRAWING: XXXXXX

DATE: AS SHOWN	DATE: 20-XX-XX
OWNER: MSS	SHEET NO. E-5.04
DATE: CC	REV: 0
DATE: 09/20/12	

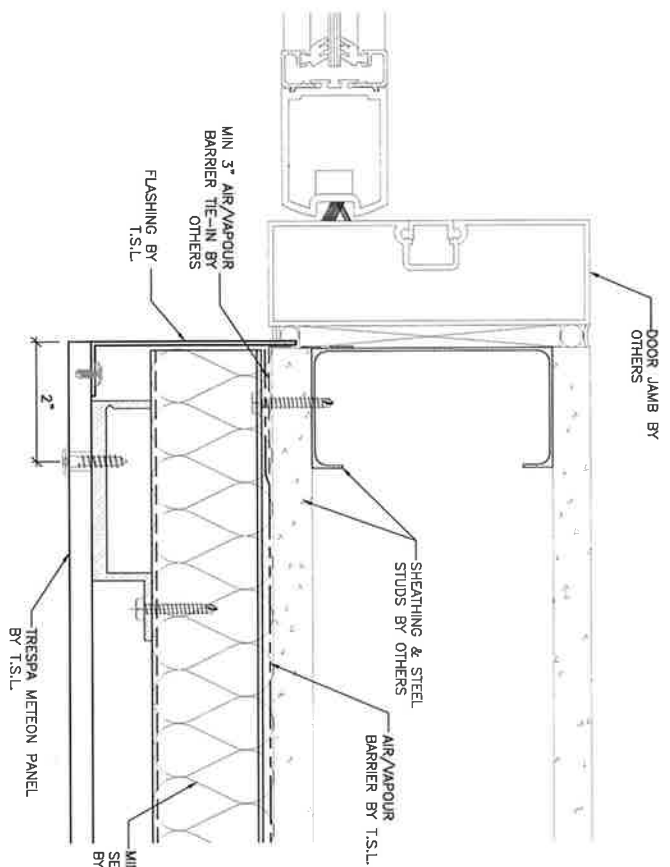

**1 WINDOW JAMB PLAN**  
 6.01 SCALE: 6"=1'-0"  
 REF: NONE

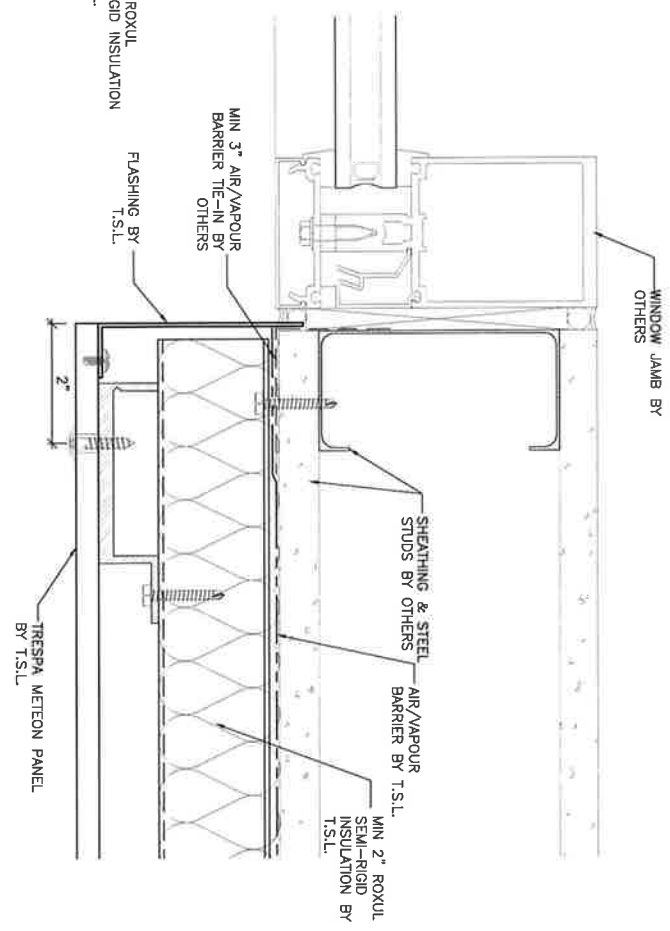

**2 DOOR JAMB PLAN**  
 6.01 SCALE: 6"=1'-0"  
 REF: NONE

"BUILDING INSPIRED VISIONS"

*Copyright Notice*  
 THIS DRAWING AND ITS CONTENTS ARE PROTECTED BY COPYRIGHT AND SHALL NOT BE REPRODUCED IN WHOLE OR IN PART WITHOUT THE EXPRESS WRITTEN PERMISSION OF THE ARCHITECT. ALL RIGHTS RESERVED. DRAWINGS ARE NOT TO BE SCALED.

REV. NO.	DESCRIPTION	DATE	BY



**THERMAL SYSTEMS**

PROJECT	LOCATION	DATE
TRESPA DETAILS	XXXXXX	XXXXXX

AS SHOWN	DATE	BY
MSS		
CG		

PROJECT NO. 90709812



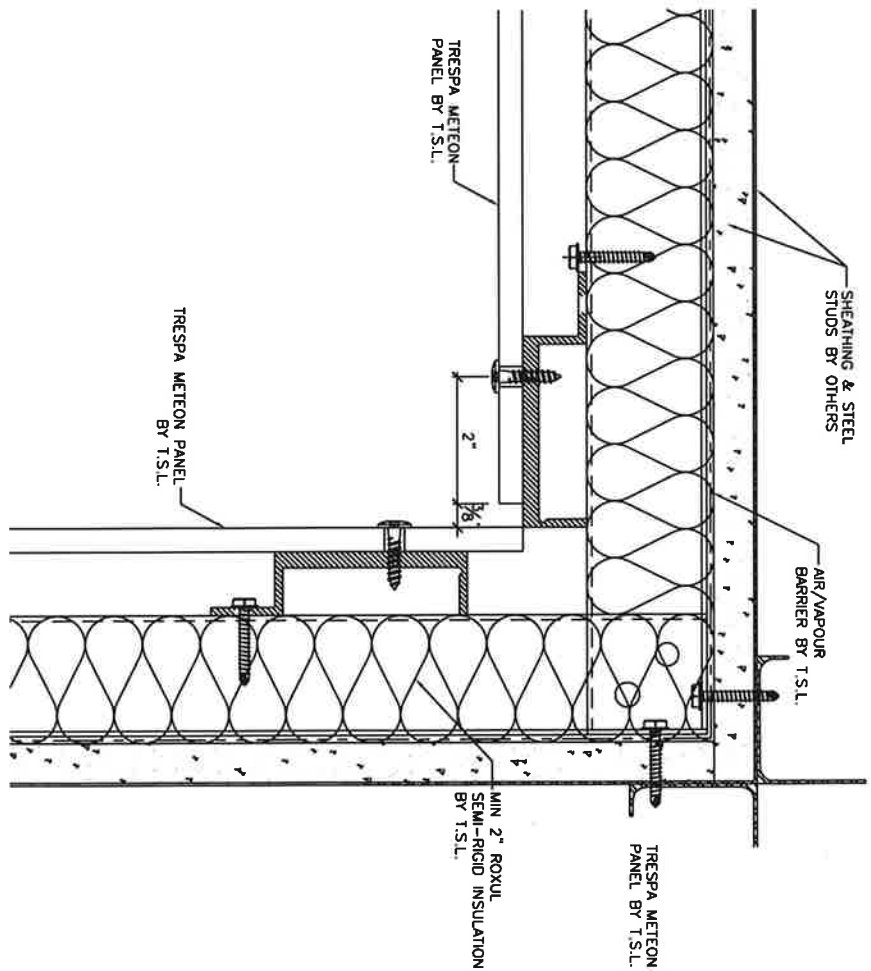

**1** INSIDE CORNER PLAN  
 SCALE: 6"=1'-0"  
 REF: NONE

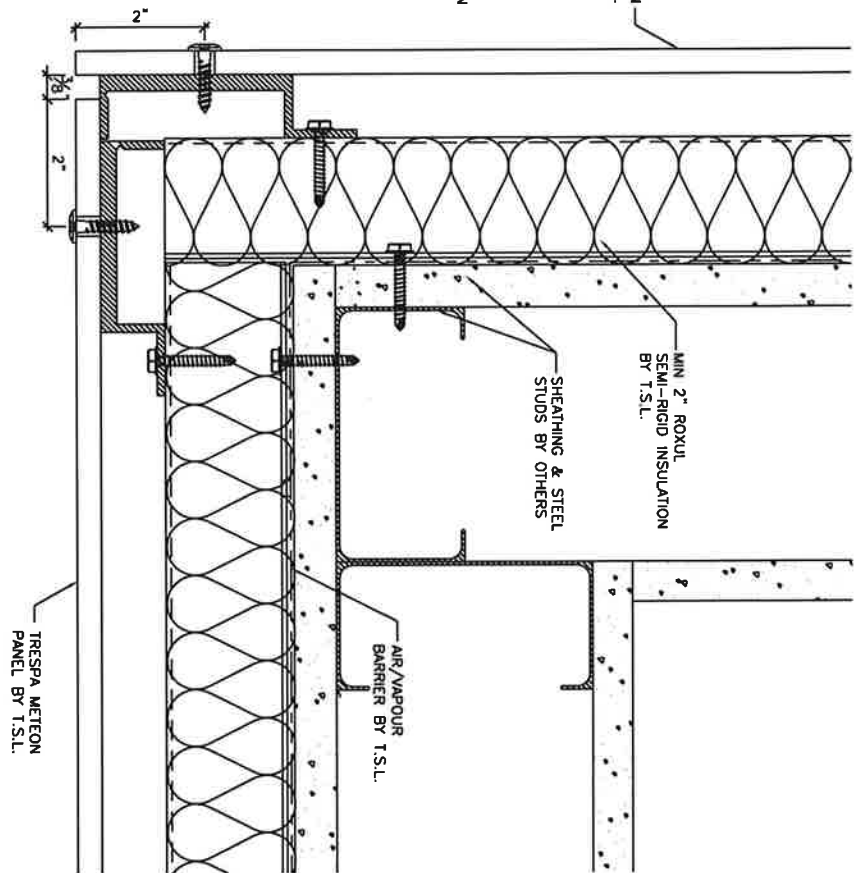

**2** OUTSIDE CORNER PLAN  
 SCALE: 6"=1'-0"  
 REF: NONE

"BUILDING INSPIRED VISIONS"

*Consultant Notice*  
 THIS DRAWING AND ITS CONTENTS ARE PROTECTED BY COPYRIGHT AND SHALL NOT BE REPRODUCED IN WHOLE OR IN PART, WITHOUT THE EXPRESS WRITTEN PERMISSION OF THERMAL SYSTEMS. THESE DRAWINGS ARE NOT TO BE SCALED.

REV. NO.	DESCRIPTION	DATE	BY



THERMAL SYSTEMS

PROJECT: TRESPA DETAILS  
 DRAWING: THERMAL SYSTEMS  
 SHEET: THERMAL SYSTEMS

SCALE: AS SHOWN	DATE: 22-01-22
DRAWN: MSS	SHEET NO: E-6.02
CHECK: CC	REV: 0
FILE NO: 20070112	

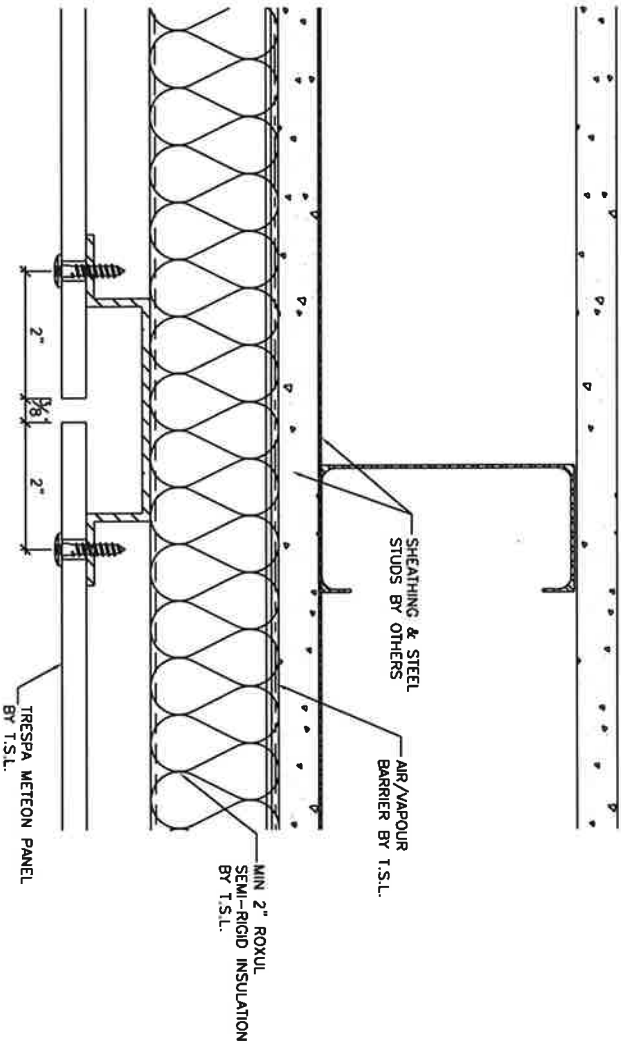

1 VERTICAL JOINT PLAN  
 SCALE: 6" = 1'-0"  
 REF: NONE

"BUILDING INSPIRED VISIONS"

**Copyright Notice**  
 THE DRAWING AND ITS CONTENTS ARE PROTECTED BY COPYRIGHT AND SHALL NOT BE REPRODUCED IN WHOLE OR IN PART WITHOUT THE EXPRESS WRITTEN PERMISSION OF THERMAL SYSTEMS. DIMENSIONS ARE NOT TO BE SCALE D.

REV. NO.	DESCRIPTION	DATE	BY



THERMAL SYSTEMS

PROJECT NO.	PLAN DETAIL
PROJECT	TRESPA DETAILS
LOCATION	XXXXXX
DRAWING NO.	XXXXXX

SCALE	AS SHOWN	DATE	20-02-24
DESIGN	MSS	SHEET NO.	E-6.03
CHECK	CC	REV.	0
FILE NO.	90070812		